



COB CANNON LP200ST



User Manual

©2022 ADJ Products, LLC all rights reserved. Information, specifications, diagrams, images, and instructions herein are subject to change without notice. ADJ Products, LLC logo and identifying product names and numbers herein are trademarks of ADJ Products, LLC. Copyright protection claimed includes all forms and matters of copyrightable materials and information now allowed by statutory or judicial law or hereinafter granted. Product names used in this document may be trademarks or registered trademarks of their respective companies and are hereby acknowledged. All non-ADJ Products, LLC brands and product names are trademarks or registered trademarks of their respective companies.

ADJ Products, LLC and all affiliated companies hereby disclaim any and all liabilities for property, equipment, building, and electrical damages, injuries to any persons, and direct or indirect economic loss associated with the use or reliance of any information contained within this document, and/or as a result of the improper, unsafe, insufficient and negligent assembly, installation, rigging, and operation of this product.

DOCUMENT VERSION



Due to additional product features and/or enhancements, an updated version of this document may be available online.

Please check www.adj.com for the latest revision/update of this manual before beginning installation and/or programming.

Date	Document Version	Software Version	DMX Channels	Notes
03/31/2022	1.0	1.0	5 / 8A / 8B / 9 / 10A / 10B / 12 / 13 / 16 / 20 channels	Initial Release.
08/24/2022	1.1	N/C	No Change	Updated Specifications.
12/01/2022	1.2	N/C	No Change	Updated RDM, Dim Modes.

Europe Energy Saving Notice

Energy Saving Matters (EuP 2009/125/EC)

Saving electric energy is a key to help protecting the environment. Please turn off all electrical products when they are not in use. To avoid power consumption in idle mode, disconnect all electrical equipment from power when not in use. Thank you!

TABLE OF CONTENTS

Introduction	4
Limited Warranty (USA Only)	5
Warranty Registration Features	6
Safety Guidelines	7
Overview	8
Installation	9
Accessory Installation	13
Remote Device Management (RDM)	14
Control Panel	15
System Menu	16
DMX Setup	19
DMX Traits	21
Color Temperature Presets	24
Color Macros Chart	25
Dim Modes	27
Remote Control Guidelines	28
Daisy Chain Power Linking Cleaning and Maintenance	30
Dimensional Drawings	31
Specifications	32

INTRODUCTION

Unpacking: Thank you for purchasing the COB Cannon LP200ST by ADJ Products, LLC. Every device has been thoroughly tested and has been shipped in perfect operating condition. Carefully check the shipping carton for damage that may have occurred during shipping. If the carton appears to have been damaged, carefully inspect your fixture for any damage and be sure all accessories necessary to operate the unit have arrived intact. In the event that damage has been found or parts are missing, please contact our toll free customer support number for further instructions. Do not return this unit to your dealer without first contacting customer support.

Introduction: The ADJ COB Cannon LP200ST is an RGBAL wash fixture. To optimize the performance of this product, please read these operating instructions carefully to familiarize yourself with the basic operations of this unit. These instructions contain important safety information regarding the use and maintenance of this unit. Please keep this manual with the unit for future reference.

Customer Support: Contact ADJ Service for any product related service and support needs. Also visit forums.adj.com with questions, comments or suggestions.

Parts: To purchase parts online visit:

<http://parts.adj.com> (US)

<http://www.adjparts.eu> (EU)

ADJ SERVICE USA - Monday - Friday 8:00am to 4:30pm PST

Voice: 800-322-6337 | Fax: 323-582-2941 | support@adj.com

ADJ SERVICE EUROPE - Monday - Friday 08:30 to 17:00 CET

Voice: +31 45 546 85 60 | Fax: +31 45 546 85 96 | support@adj.eu

ADJ PRODUCTS LLC USA

6122 S. Eastern Ave. Los Angeles, CA. 90040

323-582-2650 | Fax 323-532-2941 | www.adj.com | info@adj.com

ADJ SUPPLY Europe B.V

Junostraat 2 6468 EW Kerkrade, The Netherlands

+31 (0)45 546 85 00 | Fax +31 45 546 85 99

www.americandj.eu | info@americandj.eu

ADJ PRODUCTS GROUP Mexico

AV Santa Ana 30 Parque Industrial Lerma, Lerma, Mexico 52000

+52 (728) 282-7070

Warning! This unit is intended for indoor use only! Do not expose to rain or moisture!

CAUTION! There are no user serviceable parts inside this unit. Do not attempt any repairs yourself, as doing so will void your manufacturer's warranty. In the unlikely event your unit may require service, please contact ADJ Products, LLC.

Do not discard the shipping carton in the trash. Please recycle when ever possible.

LIMITED WARRANTY (USA ONLY)

- A. ADJ Products, LLC hereby warrants, to the original purchaser, ADJ Products, LLC products to be free of manufacturing defects in material and workmanship for a prescribed period from the date of purchase (see specific warranty period on reverse). This warranty shall be valid only if the product is purchased within the United States of America, including possessions and territories. It is the owner's responsibility to establish the date and place of purchase by acceptable evidence, at the time service is sought.
- B. For warranty service, you must obtain a Return Authorization number (RA#) before sending the product back—please contact ADJ Products, LLC Service Department at 800-322-6337. Send the product only to the ADJ Products, LLC factory. All shipping charges must be prepaid. If the requested repairs or service (including parts replacement) are within the terms of this warranty, ADJ Products, LLC will pay return shipping charges only to a designated point within the United States. If the entire instrument is sent, it must be shipped in its original package and packaging material. No accessories should be shipped with the product. If any accessories are shipped with the product, ADJ Products, LLC shall incur no liability whatsoever for loss of or damage to any such accessories, nor for the safe return thereof.
- C. This warranty is void if the product serial number and/or labels are altered or removed; if the product is modified in any manner which ADJ Products, LLC concludes, after inspection, affects the reliability of the product; if the product has been repaired or serviced by anyone other than the ADJ Products, LLC factory unless prior written authorization was issued to purchaser by ADJ Products, LLC; if the product is damaged because it was not properly maintained as set forth in the product instructions, guidelines and/or user manual.
- D. This is not a service contract, and this warranty does not include maintenance, cleaning, or periodic check-up. During the period specified above, ADJ Products, LLC will replace defective parts at its expense with new or refurbished parts, and will absorb all expenses for warranty service and repair labor by reason of defects in material or workmanship. The sole responsibility of ADJ Products, LLC under this warranty shall be limited to the repair of the product, or replacement thereof, including parts, at the sole discretion of ADJ Products, LLC. All products covered by this warranty were manufactured after August 15, 2012, and bear identifying marks to that effect.
- E. ADJ Products, LLC reserves the right to make changes in design and/or improvements upon its products without any obligation to include these changes in any products theretofore manufactured.
- F. No warranty, whether expressed or implied, is given or made with respect to any accessory supplied with products described above. Except to the extent prohibited by applicable law, all implied warranties made by ADJ Products, LLC in connection with this product, including warranties of merchantability or fitness, are limited in duration to the warranty period set forth above. And all warranties, whether expressed or implied, including warranties of merchantability or fitness, are limited in duration to the warranty period set forth above. The consumer's and/or dealer's sole remedy shall be such repair or replacement as is expressly provided above; and under no circumstances shall ADJ Product, LLC be liable for any loss and/or damage, direct and/or consequential arising out of the use of, and/or inability to use this product.
- G. This warranty is the only written warranty applicable to ADJ Products, LLC products, and supersedes all prior warranties and written descriptions of warranty terms and conditions heretofore published.

MANUFACTURER'S LIMITED WARRANTY PERIODS:

- Non-LED Lighting Products = 1-Year (365 Days) (Including Special Effect Lighting, Intelligent Lighting, UV lighting, Strobes, Fog Machines, Bubble Machines, Mirror Balls, Par Cans, Trussing, Lighting Stands, Power/Data Distribution, etc. excluding LED and lamps)
- Laser Products = 1-Year (365 Days) (excluding laser diodes which have a 6-Month Limited Warranty)
- LED Products = 2-Year (730 Days) (excluding batteries which have a 180 Day Limited Warranty)
- NOTE: 2-Year (730 Days) Limited Warranty ONLY applies to product purchased within the United States. StarTec Series = 1-Year (365 Days) (excluding batteries which have a 180 Day Limited Warranty)
- ADJ DMX Controllers = 2 Year (730 Days)
- American Audio Products = 1 Year (365 Days)

WARRANTY REGISTRATION

The COB Cannon LP200ST carries a 2 year limited warranty. Please fill out the enclosed warranty card to validate your purchase. All returned service items, whether under warranty or not, must be freight pre-paid and accompanied by a return authorization (R.A.) number. The R.A. number must be clearly written on the outside of the return package. A brief description of the problem as well as the R.A. number must also be written down on a piece of paper included in the shipping carton. If the unit is under warranty, you must provide a copy of your proof of purchase invoice. You may obtain an R.A. number by contacting our customer support team on our customer support number. All packages returned to the service department not displaying an R.A. number on the outside of the package will be returned to the shipper.

FEATURES

Featuring a high output 200-Watt COB (Chip On Board) LED engine, the ADJ COB Cannon LP200ST is a potent color mixing wash lighting fixture. It's 5-in-1 light source combines red, green, blue, amber and lime LED chips to allow the creation of a huge gamut of colors as well as a high CRI. A compact and versatile fixture, it offers a wide 80-degree native beam angle but is also supplied with both 40-degree and 50-degree lens options.

INCLUDED ITEMS

- Locking Power Cable (x1)
- 40-degree Lens (x1)
- 50-degree Lens (x1)
- Frost Filter (x1)
- UC IR Controller (x1)

IP RATING

An IP rated lighting fixture has been designed with an enclosure that effectively protects the ingress (entry) of external foreign objects such as dust and/or water. The Ingress Protection (IP) rating system is commonly expressed as "IP" followed by two numbers (i.e. IP20), where the numbers define the degree of protection. The first digit (Foreign Bodies Protection) indicates the extent of protection against particles entering the fixture and the second digit (Water Protection) indicates the extent of protection against water entering the fixture.

An IP20 rated lighting fixture, such as this one, has been designed and tested to protect against the ingress of solids as small as the size of an adult finger (approximately 12.5mm), but is NOT protected against liquid intrusion of any kind.

SAFETY GUIDELINES

THIS FIXTURE IS COMPOSED OF SOPHISTICATED ELECTRONIC COMPONENTS. TO GUARANTEE SMOOTH OPERATION, IT IS IMPORTANT TO FOLLOW ALL INSTRUCTIONS AND GUIDELINES IN THIS MANUAL. ADJ PRODUCTS, LLC IS NOT RESPONSIBLE FOR INJURY AND/OR DAMAGES RESULTING FROM THE MISUSE OF THIS FIXTURE DUE TO THE DISREGARD OF THE INFORMATION PRINTED IN THIS MANUAL. ONLY QUALIFIED AND/OR CERTIFIED PERSONNEL SHOULD PERFORM INSTALLATION OF THIS FIXTURE AND ONLY THE ORIGINAL RIGGING PARTS INCLUDED WITH THIS FIXTURE SHOULD BE USED FOR INSTALLATION. ANY MODIFICATIONS TO THE FIXTURE AND/OR THE INCLUDED MOUNTING HARDWARE WILL VOID THE ORIGINAL MANUFACTURER'S WARRANTY AND INCREASE THE RISK OF DAMAGE AND/OR PERSONAL INJURY. ONLY CERTIFIED PERSONNEL SHOULD PERFORM INSTALLATION OF THIS FIXTURE.

- PROTECTION CLASS 1 - FIXTURE MUST BE PROPERLY GROUNDED.
- THERE ARE NO USER SERVICEABLE PARTS INSIDE THIS UNIT.
- DO NOT ATTEMPT ANY REPAIRS YOURSELF; DOING SO WILL VOID YOUR MANUFACTURER'S WARRANTY. DAMAGES RESULTING FROM MODIFICATIONS TO THIS FIXTURE AND/OR THE DISREGARD OF SAFETY INSTRUCTIONS AND GUIDELINES IN THIS MANUAL VOID THE MANUFACTURER'S WARRANTY AND ARE NOT SUBJECT TO ANY WARRANTY CLAIMS AND/OR REPAIRS.
- DO NOT PLUG FIXTURE INTO A DIMMER PACK!
- NEVER OPEN THIS FIXTURE WHILE IN USE!
- UNPLUG POWER BEFORE SERVICING FIXTURE!
- NEVER TOUCH FIXTURE DURING OPERATION, AS IT MAY BE HOT!
- KEEP FLAMMABLE MATERIALS AWAY FROM FIXTURE!
- NEVER LOOK DIRECTLY INTO THE LIGHT SOURCE!
- RETINA INJURY RISK - MAY INDUCE BLINDNESS!
- SENSITIVE PERSONS MAY SUFFER AN EPILEPTIC SHOCK!
- MINIMUM DISTANCE TO OBJECTS/SURFACES IS 6.6 FEET (2 METERS)
- **AMBIENT OPERATING TEMPERATURE RANGES FROM -4°F to 113°F (-20°C TO 45°C). DO NOT OPERATE THE DEVICE WHEN AMBIENT TEMPERATURE FALLS OUTSIDE OF THIS RANGE.**
- **MINIMUM DISTANCE TO FLAMMABLE MATERIALS FROM THE SURFACE IS 1.6 FEET (0.5 METER).**
- DO NOT TOUCH the fixture housing during operation. Turn OFF the power and allow approximately 60 minutes for the fixture to cool down before servicing.
- DO NOT shake fixture, and avoid brute force when installing and/or operating fixture.
- DO NOT operate fixture if the power cord is frayed, crimped, damaged and/or if any of the power cord connectors are damaged and do not insert into the fixture securely with ease. NEVER force a power cord connector into the fixture. If the power cord or any of its connectors are damaged, replace it immediately with a new one of the same power rating.
- DO NOT block any air ventilation slots. All fan and air inlets must remain clean and never blocked. Allow approx. 6" (15cm) between fixture and other devices or a wall for proper cooling.
- When installing fixture in a suspended environment, always use mounting hardware that is no less than M10 x 25 mm, and always install fixture with an appropriately rated safety cable.
- Always disconnect fixture from main power source before performing any type of service and/or cleaning procedure.
- Only handle the power cord by the plug end. Never pull out the plug by tugging the wire portion of the cord.
- During the initial operation of this fixture, a light smoke or smell may emit from the interior of the fixture. This is a normal process and is caused by excess paint in the interior of the casing burning off from the heat associated with the lamp and will decrease gradually over time.
- Consistent operational breaks will ensure fixture will function properly for many years.
- ONLY use original packaging and materials to transport the fixture for service.

OVERVIEW

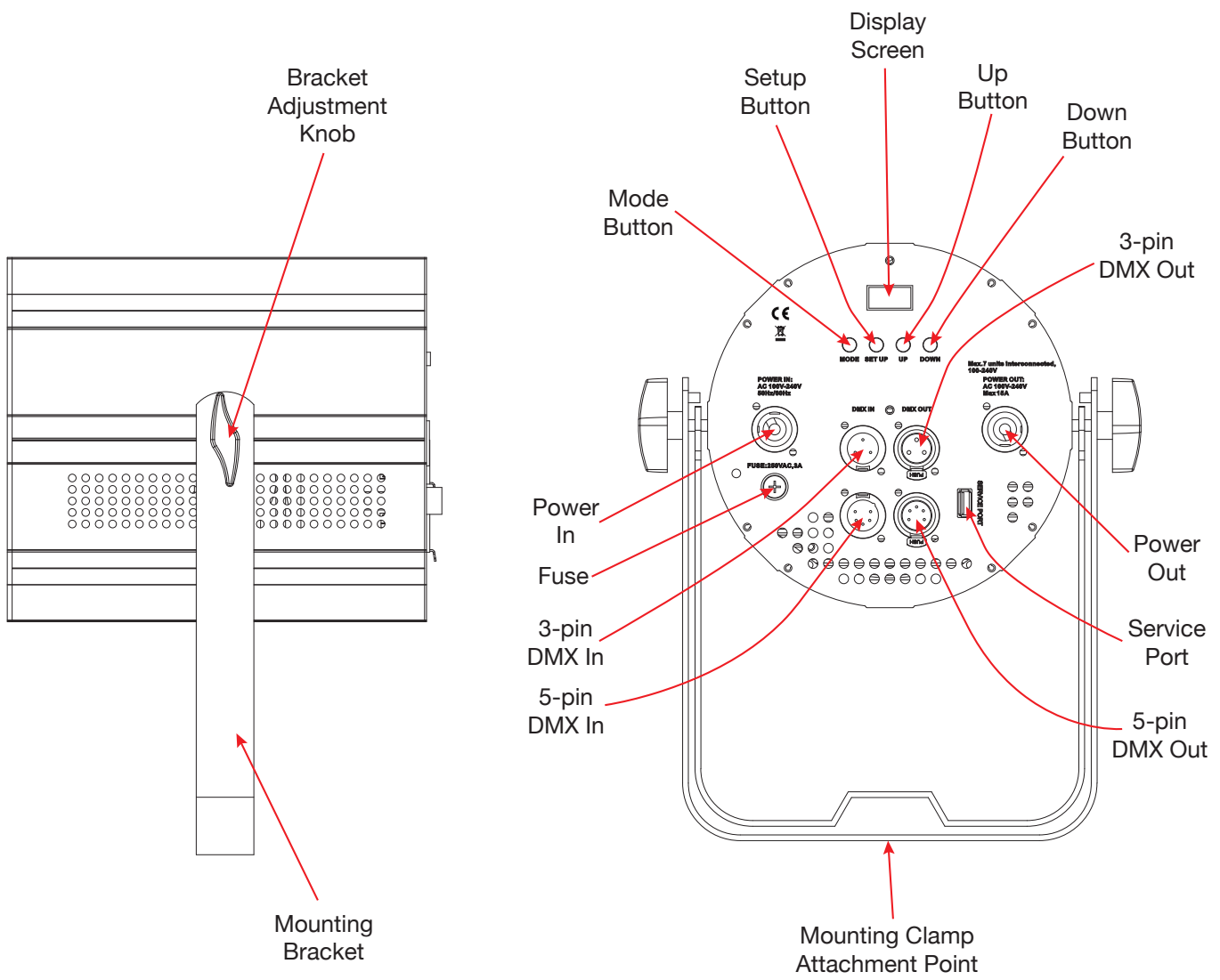

INSTALLATION



FLAMMABLE MATERIAL WARNING

Keep fixture minimum 5.0 feet (1.5m) away from flammable materials and/or pyrotechnics.



ELECTRICAL CONNECTIONS

A qualified electrician should be used for all electrical connections and/or installations.



MINIMUM DISTANCE TO OBJECTS/SURFACES IS 6.6 FEET (2 METERS).

MINIMUM DISTANCE OF FLAMMABLE MATERIALS FROM THE SURFACE IS 1.6 FEET (0.5 METER)

DO NOT INSTALL THE FIXTURE IF YOU ARE NOT QUALIFIED TO DO SO!

- Fixture **MUST** be installed following all local, national, and country commercial electrical and construction codes and regulations.
- Before rigging/mounting a single fixture or multiple fixtures to any metal truss/structure or placing the fixture(s) on any surface, a professional equipment installer **MUST** be consulted to determine if the metal truss/structure or surface is properly certified to safely hold the combined weight of the fixture(s), clamps, cables, and accessories.
- Ambient operating temperature range is **-4°F to 113°F (-20°C TO 45°C)**. Do not operate the fixture when ambient temperature falls outside of this range!
- Fixture(s) should be installed outside walking paths, seating areas, or areas where unauthorized personnel might reach the fixture by hand.
- **NEVER** stand directly below the fixture(s) when rigging, removing, or servicing.
- Overhead fixture installation must always be secured with a secondary safety attachment, such as an appropriately rated safety cable.
- Allow approximately 60 minutes for the fixture to cool down before servicing.

INDOOR USE ONLY!

This device is not intended for outdoor usage, or exposure to rain or moisture! Use of this device outdoors voids your manufacturer's warranty!

RIGGING

Overhead rigging requires extensive experience, including calculating working load limits, knowledge about installation materials being used, and periodic safety inspection of all installation material and the fixture, among other skills. If you lack these qualifications, do not attempt the installation yourself. Improper installation can result in bodily injury.

INSTALLATION

CLAMP INSTALLATION

This fixture features an attachment point for a mounting clamp located at the top the mounting bracket (see the illustration below). When mounting the fixture to a truss or any other suspended or overhead installation, be sure to secure an appropriately rated clamp (not included) to the mounting bracket. Additionally, it is also necessary to attach a separate **SAFETY CABLE** of the appropriate weight rating to the fixture, with one end of the safety cable secured around the mounting bracket and the other end secured to a suitable mounting point on the truss or mounting surface.

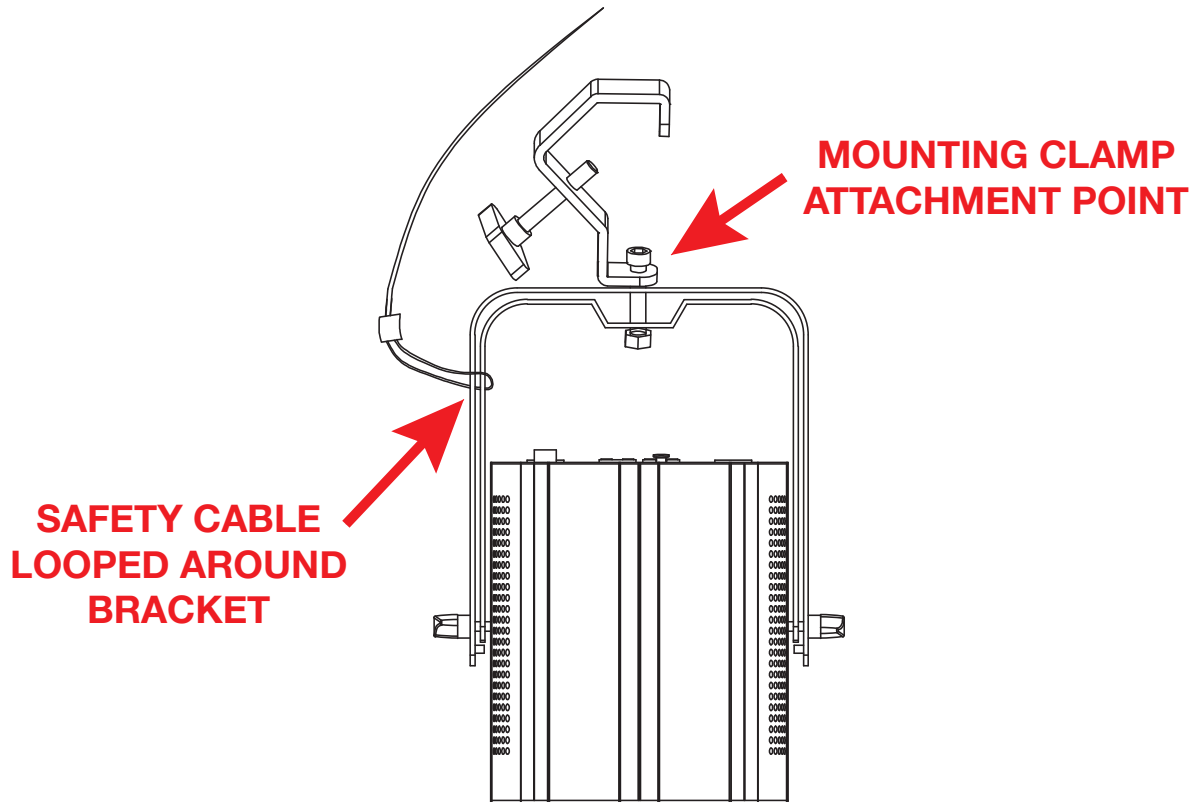

SAFETY CABLE:
**ALWAYS ATTACH A SAFETY CABLE WHENEVER INSTALLING THIS FIXTURE
IN A SUSPENDED ENVIRONMENT TO ENSURE THAT THE FIXTURE WILL NOT
FALL IF THE CLAMP FAILS.**

INSTALLATION

STAND MOUNTING

This unit can also be installed atop a tripod stand. Simply insert the threaded bolt on the top of the tripod stand through the hole in the top of the mounting yoke. Tighten the nut onto the threaded bolt to secure the mounted device in place.

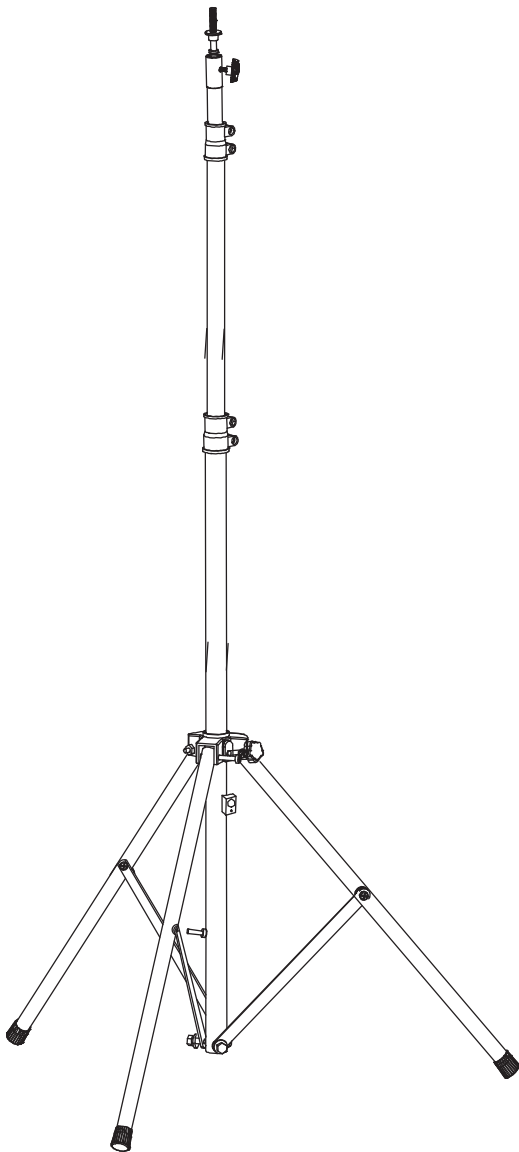
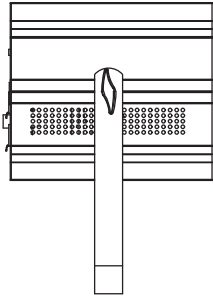

CAUTION!

MAKE SURE THAT THE TRIPOD LEGS AND ALL TELESCOPING ELEMENTS OF THE TRIPOD STAND ARE LOCKED IN PLACE BEFORE INSTALLING THE DEVICE ATOP THE STAND!

POSITION THE TRIPOD STAND AND MOUNTED DEVICE ONLY ON FLAT, STABLE SURFACES! DEPLOY TRIPOD LEGS FULLY IN ORDER TO MAXIMIZE STABILITY!

INSTALLATION

POTENTIAL INTERNAL FIXTURE DAMAGE FROM EXTERNAL SOURCES OF LIGHT BEAMS

External sources of light beams from direct sunlight, moving head lighting fixtures, and lasers which are focused directly towards the exterior housing and/or penetrate the front lens opening of ADJ lighting fixtures can cause severe internal damage, including burning of optics, dichroic color filters, glass and metal gobos, prisms, animation wheels, frost filters, irises, shutters, motors, belts, wiring, discharge lamps, and LEDs.

This issue is not unique to ADJ lighting fixtures, but rather it is a common issue with lighting fixtures from all manufacturers. Although there is no true way to completely prevent this issue from occurring, the guidelines below can reduce the risk of any potential damage if followed. Contact ADJ Service for more details.

DO NOT EXPOSE THE FIXTURE AND/OR FRONT LENS OPENING TO LIGHT BEAMS FROM DIRECT SUNLIGHT, OTHER LIGHTING OR MOVING HEAD FIXTURES, AND LASERS DURING UNPACKING, INSTALLATION, USE, AND EXTENDED IDLE TIMES OUTDOORS. DO NOT FOCUS A LIGHT BEAM FROM ONE LIGHTING FIXTURE DIRECTLY TOWARDS ANOTHER.

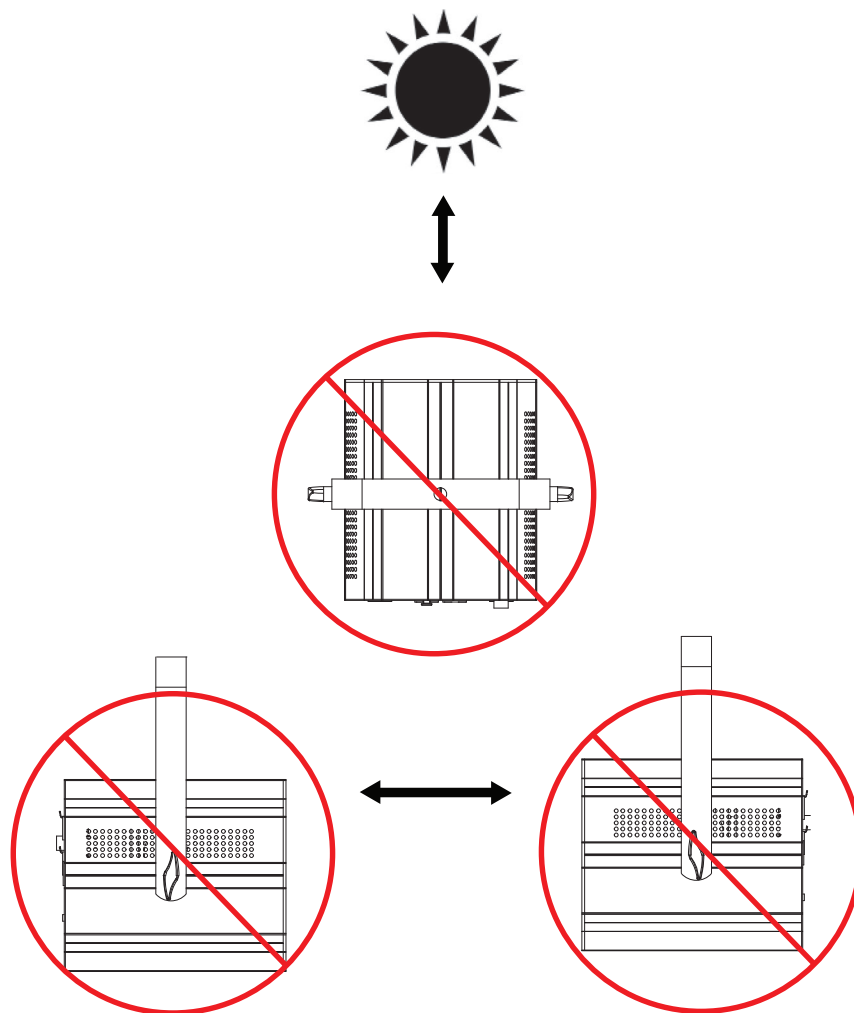

ACCESSORY INSTALLATION

40- AND 50-DEGREE LENSES, FROST FILTER

Included with this unit are additional 40- and 50-degree lenses, as well as a frost filter. To install these accessories, simply remove the lens retainer ring located inside the lens housing, as shown in the below left image. Then, carefully remove the standard lens, as shown in the below right image, and replace with the desired lens or frost filter. Replace the lens retainer ring to secure in place. *Note: The installation process is identical for all 3 accessory items.*

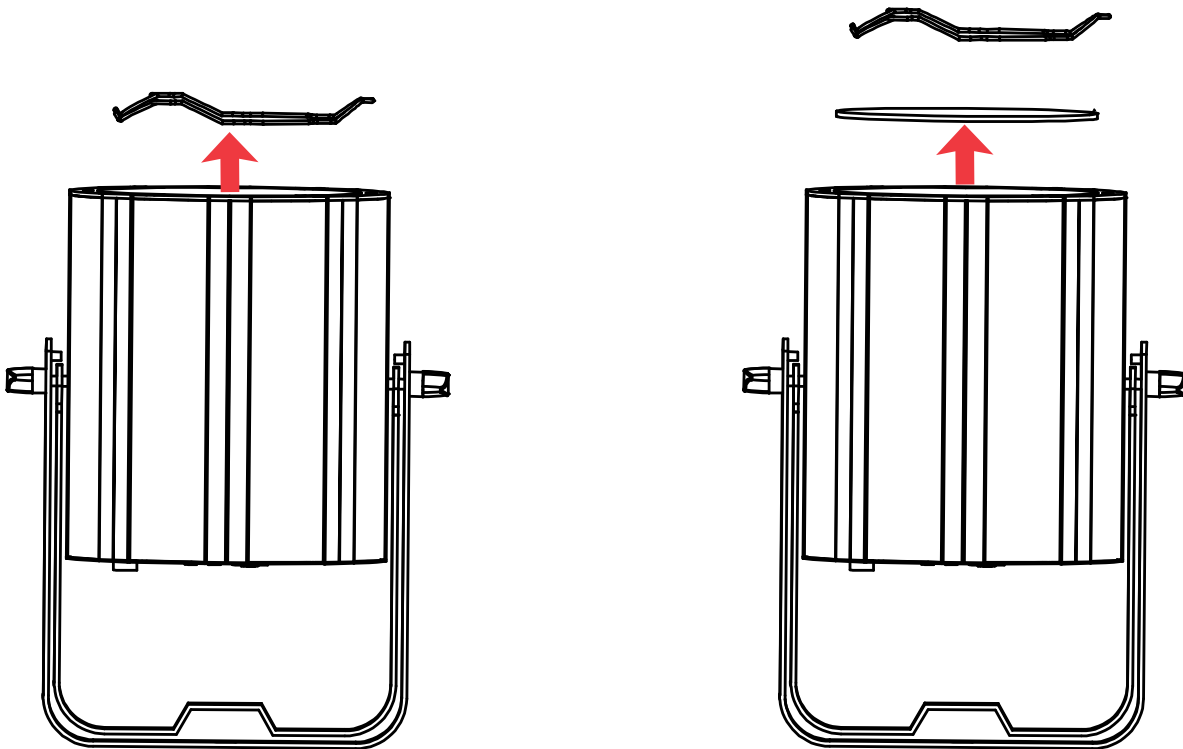

REMOTE DEVICE MANAGEMENT (RDM)

NOTE: In order for RDM to work properly, RDM enabled equipment must be used throughout the entire system, including DMX data splitters and wireless systems.

Remote Device Management (RDM) is a protocol that sits on top of the DMX512 data standard for lighting, allowing the DMX systems of the fixtures to be modified and monitored remotely. This protocol is ideal for instances in which a unit is installed in a location that is not easily accessible.

With RDM, the DMX512 system becomes bi-directional, allowing a compatible RDM enabled controller to send out a signal to devices on the wire, as well as allowing the fixture to respond (known as a GET command). The controller can then use its SET command to modify settings that would typically have to be changed or viewed directly via the unit's display screen, including the DMX Address, DMX Channel Mode, and Temperature Sensors.

FIXTURE RDM INFORMATION

RDM Code	Device ID	Device Model ID	Personality ID
0x1900	88a46	4	5ch (1), 8ch-A (2), 8ch-B (3), 9ch (4), 10ch-A (5), 10ch-B (6), 12ch (7), 13ch (8), 16ch (9), 20ch (a)

Please be aware that **not all RDM devices support all RDM features**, and therefore it is important to check beforehand to ensure that the equipment that you are considering includes all of the features that you require.

The following parameters are accessible in RDM on this device:

Device Info
Manufacturer Label
Device Label
Software Version Label
DMX Personality
DMX Personality Description
DMX Start Address
Sensor Definition
Sensor Value
Curve (Dim Curve)
Curve Description
Modulation Frequency (Led Refresh Rate)
Modulation Frequency Description
Output Response Time (Dim Mode)
Output Response Time Description

CONTROL PANEL

The fixture includes an easy to navigate system menu control panel display where all necessary settings and adjustments are made. (See image below)

- **MODE:** Cycles through the main menu options and/or return to previous menu without making changes.
- **DOWN/UP:** Scroll through options in the selected menu.
- **SETUP:** Select highlighted option and/or confirm selection.

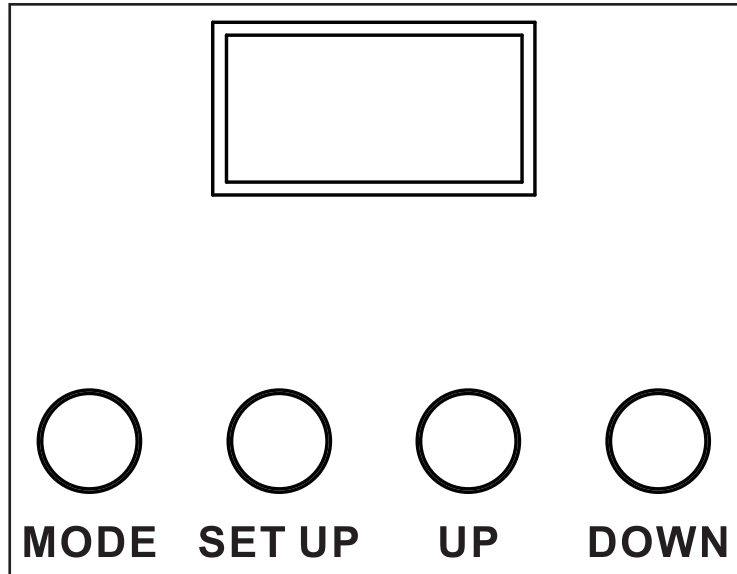

DISPLAY SCREEN LOCK

When the Display Lock setting is set to 1~10min, the display screen will automatically lock if there is no activity for the specified length of time. To unlock the display screen, simply press and hold the MODE button for 3 seconds. Alternately, when the Display Lock setting is set to OFF, the display screen will never automatically lock. However, it can still be manually locked by pressing and holding the MODE button for 2 seconds. To unlock, press and hold the MODE button for 3 seconds.

SYSTEM MENU

DMX SET	Address	001 - 512		Set DMX address
	Ch. Mode	5ch		Select DMX mode
		8ch-A		
		8ch-B		
		9ch		
		10ch-A		
		10ch-B		
		12ch		
		13ch		
		16ch		
	20ch			
	No DMX	Hold		Holds last used DMX setup in the event that DMX signal is lost
		Blackout		Takes all DMX channels to 0 in the event that DMX signal is lost
		Manual		Defaults to manual settings when DMX signal is lost
Int. Prog		Run last set internal program in the event that DMX signal is lost		
PERSONALITY	Primary/Secondary Mode	Primary / Secondary		
	IR Remote	On / Off		
	RDM	On / Off		
	Dim Mode	Standard		
		Stage		
		TV		
		Archi.		
		Theatre		
		Stage 2		
		Dim Speed	0.1s - 10.0s	
	Dim Curve	Linear		
		Square		
		Inv. Squa		
S. Curve				
LED Rfrsh	900Hz, 1000Hz, 1100Hz, 1200Hz , 1300Hz, 1400Hz, 1500Hz, 2500Hz, 4000Hz, 5000Hz, 10KHz, 15KHz, 20KHz, 25KHz		LED Refresh Rate	

CONTINUED ON NEXT PAGE

SYSTEM MENU

PERSONALITY (continued)	Display	Save Dlay	1 - 10			
		Lock	Off, 30s - 10min			
		Rotate Display 180	Yes			Display flipped
			No			Display in normal orientation
	Auto				Display automatically rotates to keep readout upright	
	Service	Passcode = 050	Calibrat	Red 000 - 255		
				Green 000 - 255		
				Blue 000 - 255		
				Amber 000 - 255		
				Lime 000 - 255		
			USB Powr	On / Off		
			S. Update	Yes / No	Software update	
			Restore	Yes / No	Return to factory settings	
			Edit RDM UID	xxxxxx	Change RDM UID	
MANUAL	Red	000 - 255		Manually adjust red		
	Green	000 - 255		Manually adjust green		
	Blue	000 - 255		Manually adjust blue		
	Amber	000 - 255		Manually adjust amber		
	Lime	000 - 255		Manually adjust lime		
	Clr Macro	00 - 64		Select color macro		
	Clr Temp	000 - 255		Manually adjust color temp		
	Clr Temp Pr	000 - 255		Select color temp preset		
	Strobe	000 - 255		Manually adjust strobe		
	Mastr Dim	000 - 255		Manually adjust master dimmer		
	Auto Prog	000 - 255		Select auto program		
	Prog Spd	000 - 255		Manually adjust program speed		
	Prof Fade	000 - 255		Manually adjust program fade		

CONTINUED ON NEXT PAGE

SYSTEM MENU

INT PROGS	Prog 0	Speed	000 - 255			
		Fade	000 - 255			
		Sound	On / Off	000 - 255		
	Prog 1	Speed	000 - 255			
		Fade	000 - 255			
		Sound	On / Off	000 - 255		
		
	Prog 13	Speed	000 - 255			
		Fade	000 - 255			
		Sound	On / Off	000 - 255		
	INFO	Hours	PwrOnHr1	xxxxxx Hours		Total hours fixture has been powered on, non resettable
			PwrOnHr2	xxxxxx Hours		Hours since fixture has been powered on since last reset, resettable
PwrOnRst			Passcode = 050		Reset power on time	
Temp		xxx F / xxx C			Display current temp	
		MaxTemp1	xxx F / xxx C		Max temp since last reset, resettable	
		MaxTemp2	xxx F / xxx C		All time max temp, non resettable	
		Temp Rst	Yes / No	Passcode = 050	Reset max temp	
DMX Values		Red			Display current value for each DMX channel	
		Green				
		...				
		Auto Prog				
RDM UID		xxxxxx				
Error Logs		Fixture errors (list one by one)				
	Reset Error Log	Yes / No	Passcode = 050	Reset error log		
Soft Vers	x.xx					

DMX SETUP

DMX-512: DMX is short for Digital Multiplex. This is a universal protocol used as a form of communication between intelligent fixtures and controllers. A DMX controller sends DMX data instructions from the controller to the fixture. DMX data is sent as serial data that travels from fixture to fixture via the DATA “IN” and DATA “OUT” XLR terminals located on all DMX fixtures (most controllers only have a DATA “OUT” terminal).

DMX Linking: DMX is a language allowing all makes and models of different manufacturers to be linked together and operate from a single controller, as long as all fixtures and the controller are DMX compliant. To ensure proper DMX data transmission, try to use the shortest cable path possible when using several DMX fixtures. The order in which fixtures are connected in a DMX line does not influence the DMX addressing. For example, a fixture assigned a DMX address of 1 may be placed anywhere in a DMX line: at the beginning, at the end, or anywhere in the middle. When a fixture is assigned a DMX address of 1, the DMX controller knows to send DATA assigned to address 1 to that unit, no matter where it is located in the DMX chain.

Data Cable (DMX Cable) Requirements (For DMX Operation): The COB Cannon LP200ST can be controlled via DMX-512 protocol, and features multiple DMX channel modes. Your unit and your DMX controller can operate with either a 3-pin or 5-pin XLR connector for data input and data output. If you are making your own cables, be sure to use standard 110-120 Ohm shielded cable (This cable may be purchased at almost all professional lighting stores). Your cables should be made with a male XLR connector at one end and a female XLR connector at the other. Also remember that DMX cable must be daisy chained and cannot be split.

Special Note: Line Termination. When longer runs of cable are used, you may need to use a terminator on the last unit to avoid erratic behavior. A terminator is a 110-120 ohm 1/4 watt resistor which is connected between pins 2 and 3 of a male XLR connector (DATA + and DATA -). This unit is inserted in the female XLR connector of the last unit in your daisy chain to terminate the line. Using a cable terminator (ADJ part number Z-DMX/T) will decrease the chances of erratic behavior.

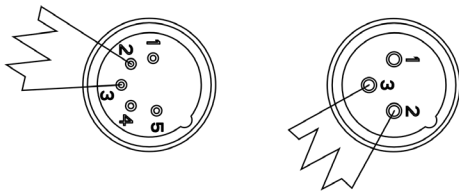

A DMX512 terminator reduces signal errors, avoiding most signal reflection interference. Connect PIN 2 (DMX-) and PIN 3 (DMX+) of the last fixture in series with a 120 Ohm, 1/4 W Resistor to terminate the DMX512.

DMX SETUP

DMX ADDRESSING

All fixtures should be given a DMX starting address when operating with a DMX controller, in order to ensure that the correct fixture responds to the correct control signal. This digital starting address is the channel number from which the fixture starts to “listen” to the digital control signal sent out from the DMX controller. The starting DMX address is configured by setting the correct DMX address on the control panel display on the fixture.

You can set the same starting address for multiple fixtures, or set different addresses for each individual fixture. Setting multiple fixtures to the same DMX address will cause all those fixtures to react in the same way. In this case, please note that changing the settings of one channel will affect all the fixtures simultaneously.

If you set each fixture to a different DMX address, each unit will start to “listen” to the channel number you have set, based on the quantity of DMX channels of each fixture. That means changing the settings of one channel will only affect the selected fixture.

As an example, when operating this device in 5 channel mode, you should set the starting DMX address of the first unit to 1, the second unit to 6 (1 + 5), the third unit to 11 (1 + 5 + 5), and so on. (See the chart below for more details.)

Channel Mode	Unit 1 Address	Unit 2 Address	Unit 3 Address	Unit 4 Address
5-channel	1	6	11	16
8A / 8B-channel	1	9	17	25
9-channel	1	10	19	28
10A / 10B channel	1	11	21	31
12-channel	1	13	25	37
13-channel	1	14	27	40
16-channel	1	17	33	49
20-channel	1	21	41	61

DMX TRAITS

CHANNEL										DMX VALUE	FUNCTION
5CH	8CH A	8CH B	9CH	10CH A	10CH B	12CH	13CH	16CH	20CH		
1	1		1	1	1	1	1	1	1	000 - 255	Red , 0% to 100%
				2					2	000 - 255	Red Fine
2	2		2	3	2	2	2	2	3	000 - 255	Green , 0% to 100%
				4					4	000 - 255	Green Fine
3	3		3	5	3	3	3	3	5	000 - 255	Blue , 0% to 100%
				6					6	000 - 255	Blue Fine
4	4		4	7	4	4	4	4	7	000 - 255	Amber , 0% to 100%
				8					8	000 - 255	Amber Fine
5	5		5	9	5	5	5	5	9	000 - 255	Lime , 0% to 100%
				10					10	000 - 255	Lime Fine
		1			6	6	6	6	11	000 - 255	Color Macros , please see Color Macros Chart section of this manual
		2	6		7		7	7	12	000 - 255	Color Temperature , 2300K - 9900K linear
											Shutter / Strobe
										000 - 031	LEDs off
										032 - 063	LEDs On
										064 - 095	Strobe Effect, slow to fast
	6	3	7		8	7	8	8	13	096 - 127	LEDs On
										128 - 159	Pulse Effect in Sequences
										160 - 191	LEDs On
										192 - 223	Random Strobe Effect, slow to fast
										224 - 255	LEDs On
	7	4	8		9	8	9	9	14	000 - 255	Dimmer Intensity , 0% to 100%
	8	5	9		10	9	10	10		000 - 255	Dimmer Fine
											Auto Programs
										000 - 010	Off
						10		11	15	011 - 026	Auto Program 1
										027 - 043	Auto Program 2
										044 - 060	Auto Program 3
										061 - 076	Auto Program 4

CONTINUED ON NEXT PAGE

DMX TRAITS

CHANNEL										DMX VALUES	FUNCTION	
5CH	8CH A	8CH B	9CH	10CH A	10CH B	12CH	13CH	16CH	20CH			
						10		11	15		<i>Auto Programs (continued)</i>	
										077 - 093	Auto Program 5	
										094 - 110	Auto Program 6	
										111 - 126	Auto Program 7	
										127 - 143	Auto Program 8	
										144 - 160	Auto Program 9	
										161 - 176	Auto Program 10	
										177 - 193	Auto Program 11	
										194 - 210	Auto Program 12	
										211 - 226	Auto Program 13	
										227 - 255	No Function	
						11		12	16	000 - 255	<i>Auto Programs Speed, slow to fast</i>	
						12		13	17	000 - 255	<i>Auto Programs Fade, least to most</i>	
											<i>Dim Mode</i>	
										000 - 020	Default to unit setting	
										021 - 040	Standard	
										041 - 060	Stage	
										061 - 080	TV	
										081 - 100	Architectural	
										101 - 120	Theatre	
										121 - 140	Stage 2	
											<i>Dim Speed</i>	
		6						11	14	18	141	0.1s
											142	0.2s
											143	0.3s
											144	0.4s
											145	0.5s
											146	0.6s
											147	0.7s
											148	0.8s
											149	0.9s
											150	1.0s
											151	1.5s

CONTINUED ON NEXT PAGE

DMX TRAITS

CHANNEL										DMX VALUES	FUNCTION
5CH	8CH A	8CH B	9CH	10CH A	10CH B	12CH	13CH	16CH	20CH		
		6					11	14	18		<i>Dim Speed (continued)</i>
										152	2.0s
										153	3.0s
										154	4.0s
										155	5.0s
										156	6.0s
										157	7.0s
										158	8.0s
										159	9.0s
										160	10.0s
										161 - 255	Default to unit setting
		7					12	15	19		<i>Dim Curves</i>
										000 - 020	Square
										021 - 040	Linear
										041 - 060	Inv. Squa.
										061 - 080	S. Curve
										081 - 255	No function
		8					13	16	20		<i>Refresh Rates</i>
										000 - 015	Default to unit setting
										016 - 030	900 Hz
										031 - 045	1000 Hz
										046 - 060	1100 Hz
										061 - 075	1200 Hz
										076 - 090	1300 Hz
										091 - 105	1400 Hz
										106 - 120	1500 Hz
										121 - 135	2500 Hz
										136 - 150	4000 Hz
										151 - 165	5000 Hz
										166 - 180	10,000 Hz
										181 - 195	15,000 Hz
										196 - 210	20,000 Hz
										211 - 225	25,000 Hz
										226 - 255	No function

COLOR TEMPERATURE PRESETS

COLOR TEMP	DMX VALUE	R	G	B	A	L
Off	000 - 015	0	0	0	0	0
2300K	016 - 031	150	4	4	255	255
2600K	032 - 047	130	20	10	255	255
2800K	048 - 063	120	30	15	255	255
3100K	064 - 079	110	45	15	255	255
3400K	080 - 095	100	55	20	255	255
3800K	096 - 111	90	70	25	255	255
4100K	112 - 127	80	80	30	255	255
4500K	128 - 143	80	85	40	255	255
4900K	144 - 159	80	95	50	255	255
5500K	160 - 175	75	110	60	255	255
6000K	176 - 191	75	110	70	255	255
7000K	192 - 207	75	125	87	255	255
8000K	208 - 223	60	135	95	255	255
9000K	224 - 239	55	150	103	255	255
9900K	240 - 255	55	165	117	255	255

COLOR MACROS CHART

COLOR MACRO NO.	DMX VALUE	COLOR TEMP	RED	GREEN	BLUE	AMBER	LIME
Off	000	n/a	0	0	0	0	0
Macro 1	001 - 004	n/a	0	255	255	1	116
Macro 2	005 - 008	n/a	127	255	212	1	124
Macro 3	009 - 012	n/a	151	125	3	255	43
Macro 4	013 - 016	n/a	0	0	255	1	0
Macro 5	017 - 020	n/a	138	43	226	1	177
Macro 6	021 - 024	n/a	223	108	7	255	77
Macro 7	025 - 028	n/a	165	42	42	1	200
Macro 8	029 - 032	n/a	95	158	160	44	71
Macro 9	033 - 036	n/a	171	36	0	120	255
Macro 10	037 - 040	n/a	127	255	0	1	255
Macro 11	041 - 044	n/a	210	105	30	1	22
Macro 12	045 - 048	n/a	255	15	18	255	174
Macro 13	049 - 052	n/a	100	149	237	3	0
Macro 14	053 - 056	n/a	255	0	10	255	144
Macro 15	057 - 060	n/a	220	20	60	1	0
Macro 16	061 - 064	n/a	0	255	255	0	12
Macro 17	065 - 068	n/a	6	0	139	1	3
Macro 18	069 - 072	n/a	0	139	139	2	5
Macro 19	073 - 076	n/a	0	111	0	1	24
Macro 20	077 - 080	n/a	255	0	2	21	3
Macro 21	081 - 084	n/a	188	0	3	255	44
Macro 22	085 - 088	n/a	255	12	0	77	62
Macro 23	089 - 092	n/a	255	130	25	229	30
Macro 24	093 - 096	n/a	140	0	139	2	135
Macro 25	097 - 100	n/a	255	140	0	1	0
Macro 26	101 - 104	n/a	153	50	204	1	5
Macro 27	105 - 108	n/a	143	188	143	1	35
Macro 28	109 - 112	n/a	72	61	139	4	2
Macro 29	113 - 116	n/a	0	206	209	2	2
Macro 30	117 - 120	n/a	255	0	4	11	8
Macro 31	121 - 124	n/a	148	0	211	5	2
Macro 32	125 - 128	n/a	255	20	147	1	0
Macro 33	129 - 132	n/a	0	191	255	2	3
Macro 34	133 - 136	n/a	160	0	26	0	4
Macro 35	137 - 140	n/a	34	139	34	1	1
Macro 36	141 - 144	n/a	255	0	255	2	0
Macro 37	145 - 148	n/a	255	215	0	1	1
Macro 38	149 - 152	n/a	5	255	190	3	11
Macro 39	153 - 156	n/a	12	255	62	95	49
Macro 40	157 - 160	n/a	5	209	255	15	170

CONTINUED ON NEXT PAGE

COLOR MACROS CHART

COLOR MACRO NO.	DMX VALUE	COLOR TEMP	RED	GREEN	BLUE	AMBER	LIME
Macro 41	161 - 164	n/a	0	5	128	5	5
Macro 42	165 - 168	n/a	255	105	180	2	1
Macro 43	169 - 172	n/a	7	255	25	70	77
Macro 44	173 - 176	n/a	147	164	212	0	2
Macro 45	177 - 180	n/a	2	255	15	3	19
Macro 46	181 - 184	n/a	0	38	86	0	0
Macro 47	185 - 188	n/a	255	0	5	121	10
Macro 48	189 - 192	n/a	5	148	209	5	19
Macro 49	193 - 196	n/a	1	255	62	93	44
Macro 50	197 - 200	2300K > 90 CRI	150	4	4	255	255
Macro 51	201 - 204	2600K > 90 CRI	140	15	8	255	255
Macro 52	205 - 208	2800K > 90 CRI	130	25	10	255	255
Macro 53	209 - 212	3100K > 90 CRI	110	30	15	255	255
Macro 54	213 - 216	3400K > 90 CRI	100	50	20	255	255
Macro 55	217 - 220	7000K > 90 CRI	75	110	70	255	255
Macro 56	221 - 224	8000K > 90 CRI	75	125	85	255	255
Macro 57	225 - 228	3800K > 90 CRI	90	60	25	255	255
Macro 58	229 - 232	4100K > 90 CRI	80	71	30	255	255
Macro 59	233 - 236	4500K > 90 CRI	80	85	38	255	255
Macro 60	237 - 240	4900K > 90 CRI	80	95	46	255	255
Macro 61	241 - 244	5500K > 90 CRI	75	110	55	255	255
Macro 62	245 - 248	6000K > 90 CRI	75	110	70	255	255
Macro 63	249 - 252	9000K > 90 CRI	65	45	97	255	255
Macro 64	253 - 255	9900K > 90 CRI	55	165	117	255	255

DIM MODES

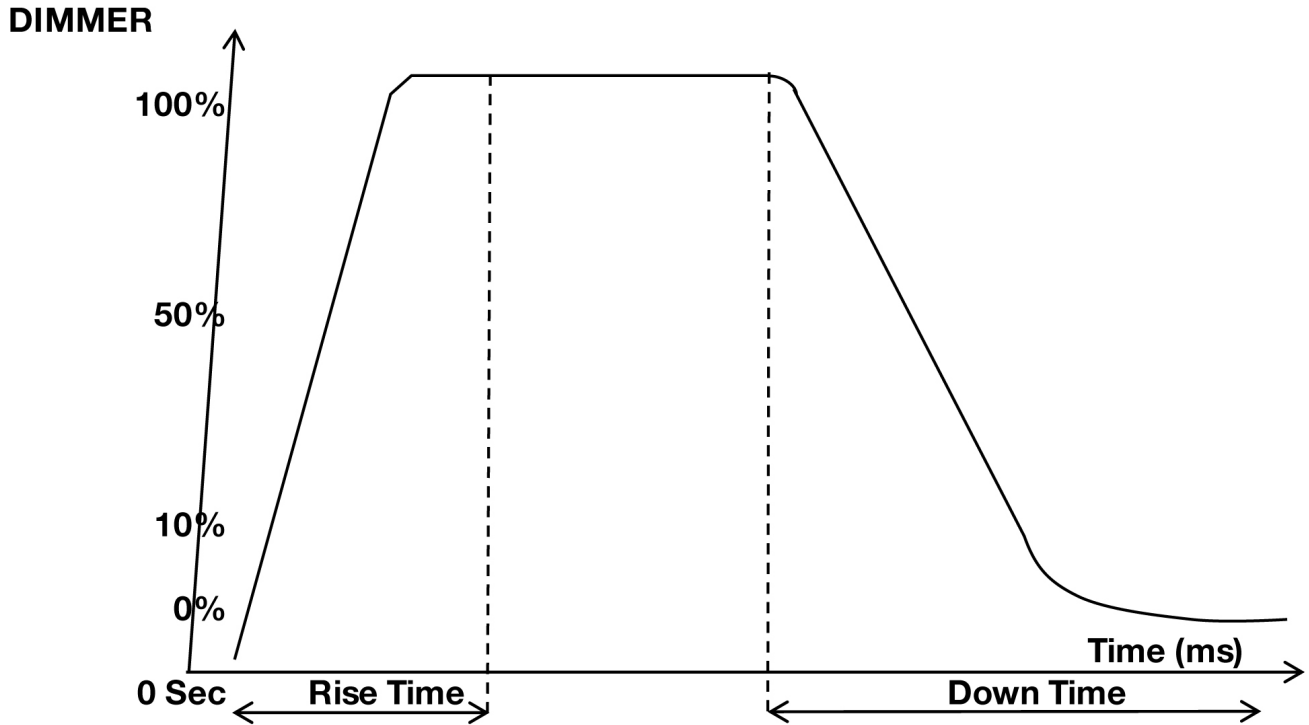

Dimming Curve Ramp Effect	0 sec Fade Time		1 sec Fade Time	
	Rise Time (ms)	Down Time (ms)	Rise Time (ms)	Down Time (ms)
Standard (default)	0	0	0	0
Stage	780	1100	1540	1660
TV	1180	1520	1860	1940
Architectural	1380	1730	2040	2120
Theatre	1580	1940	2230	2280
Stage 2	0	1100	0	1660

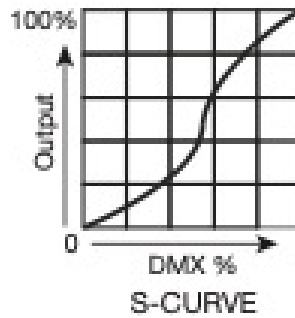
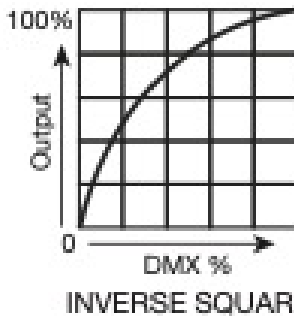
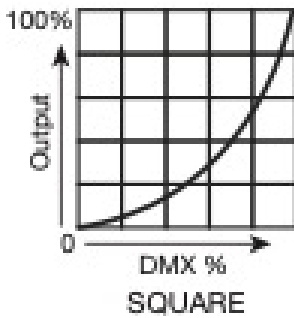
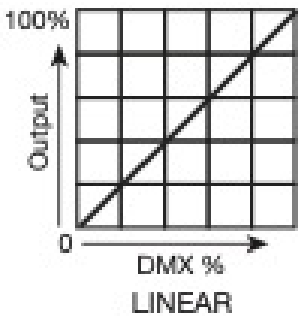

REMOTE CONTROL GUIDELINES

WIRELESS SETUP

There are many factors that can affect and/or interrupt a wireless signal, including walls, glass, metal, objects, and people. Therefore, the following guidelines are recommended in order to maximize the chances of having a clear path for the wireless signal to reach the device:

- Install the device a minimum of 9.8 ft (3m) above audiences and/or ground level.
- Arrange the wireless antenna in an upright, vertical position.
- Position devices in direct line of sight of the transmitting controller.

Careful planning and testing of the selected installation location is critical in order to ensure optimized, reliable wireless operation.



REMOTE USAGE

This device can be operated wirelessly using the ADJ UC IR remote unit. In order to control the device, the IR Remote setting in the system menu's Personality sub-menu must be set to the "On" configuration, and the handheld remote must be aimed at the front of the fixture. Maximum effective range is 30 feet (9 meters).

Please note that the unit can only be controlled when it has been set to Primary mode. The unit will NOT respond to commands when it has been set to Secondary mode.

REMOTE CONTROL GUIDELINES

REMOTE FUNCTIONS

The functions available on the ADJ UC IR remote unit are detailed below:

- **Standby** - Press once to black out the fixture, and press again to return the fixture to the original state.
- **Full On** - Press to fully illuminate the device.
- **Fade/Gobo** - Press to cycle between Color Fade, Color Change, and Auto Run Mode.
- **“Dimmer+”** and **“Dimmer-”** - Use to adjust color output intensity when running in Color Mode.
- **Strobe** - Press to activate the strobing function, then use the number keys 1-4 to select strobe speed. 1 is the slowest speed, and 4 is the fastest.
- **Color** - Press to activate Color Mode, then use buttons 1-9 to select the desired color.
- **Number Keys (1-9)** - In Strobe Mode, buttons 1-4 are used to select strobe speed. In Color Mode, buttons 1-9 are used to select the desired color. In Show Mode, buttons 1-9 are used to select the desired show.
- **Sound On** and **Sound Off** - Activate or deactivate sound active mode.
- **Show 0** - Press to activate Show Mode, then use the number keys to select the desired show. Shows 1-9 are selected by pressing buttons 1-9, Show 10 by pressing the Show 0 button twice, and Show 11 by pressing button 1 twice.



DAISY CHAIN POWER LINKING

These units have the capability to be daisy chained together via the power in/out ports. **7 units is the maximum number of that can be linked together in this manner.**

DO NOT EXCEED THE NUMBER OF UNITS LISTED ABOVE.

DO NOT MIX MAKE AND MODEL TYPES WHEN DAISY CHAINING! All units that are connected in this manner must be of the same make and model type.

CLEANING AND MAINTENANCE

DISCONNECT POWER BEFORE PERFORMING ANY MAINTENANCE!

CLEANING

Frequent cleaning is recommended to ensure proper function, optimized light output, and an extended life. The frequency of cleaning depends on the environment in which the fixture operates: damp, smoky, or particularly dirty environments can cause greater accumulation of dirt on the fixture's optics. Clean the external lens surface periodically with a soft cloth to avoid dirt/debris accumulation.

NEVER use alcohol, solvents, or ammonia-based cleaners.

MAINTENANCE

Regular inspections are recommended to ensure proper function and extended life. There are no user serviceable parts inside this fixture. Please refer all other service issues to an authorized ADJ service technician. Should you need any spare parts, please order genuine parts from your local ADJ dealer.

Please refer to the following points during routine inspections:

- A detailed electrical check by an approved electrical engineer every three months, to make sure the circuit contacts are in good condition and prevent overheating.
- Be sure all screws and fasteners are securely tightened at all times. Loose screws may fall out during normal operation, resulting in damage or injury as larger parts could fall.
- Check for any deformations on the housing, color lenses, rigging hardware, and rigging points (ceiling, suspension, trussing). Deformations in the housing could allow for dust or liquids to enter into the fixture. Damaged rigging points or unsecured rigging could cause fixture to fall and seriously injure a person(s).
- Electric power supply cables must not show any damage, material fatigue, or sediments.

NEVER remove the ground prong from the power cable.

DIMENSIONAL DRAWINGS

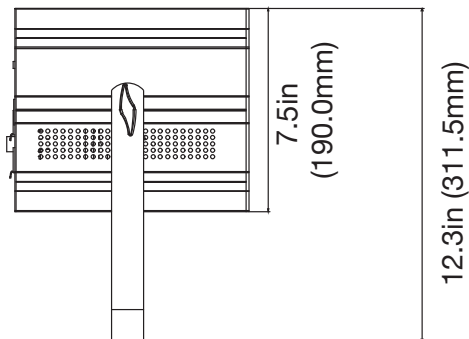
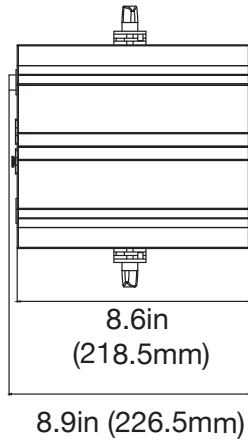
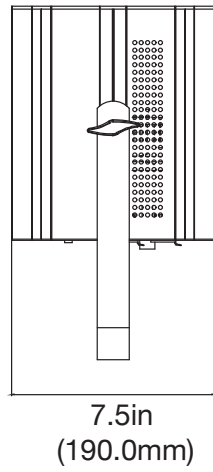
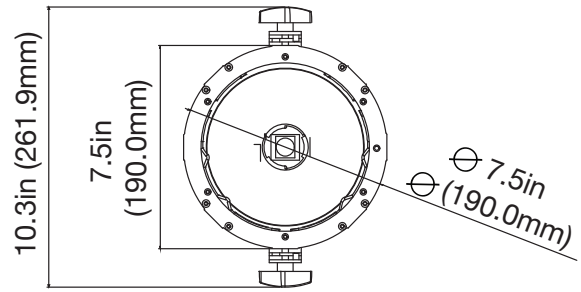
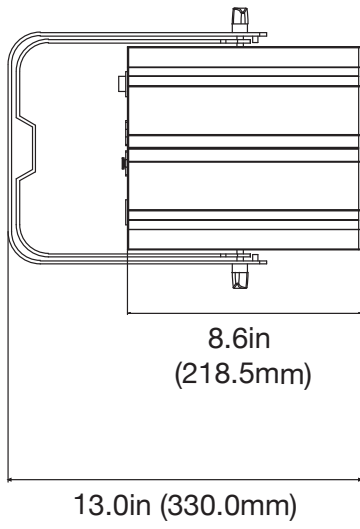

SPECIFICATIONS

OPTICAL:

- Light Source: 1x 200-Watt COB (Chip on Board), RGBAL (Red, Green, Blue, Amber & Lime), LED Engine
- LED Engine Life Rating: Approximately 50,000 hrs
- CRI: >90
- Color Temperature: 2300~9900K
- 80-degree beam angle
- Includes lens kit to change to 40-degrees or 50-degrees beam angle

CONNECTIONS:

- 3-pin & 5-pin XLR connectors for DMX data linking
- Indoor locking power In & Out connections to daisy chain power (up to 7 fixtures)
- USB Service Port

CONTROL:

- 10 DMX Channel modes (5Ch, 8Ch-A, 8Ch-B, 9Ch, 10Ch-A, 10Ch-B, 12Ch, 13Ch, 16Ch, 20Ch)
- Linear color temperature control via DMX
- Built-in color temperature presets accessible via DMX
- 64 built-in color macros
- 4-button OLED display on rear panel
- Compatible with the ADJ UC IR remote control (included)
- LED pulse and strobe effect
- Electronic Dimming: 0 - 100%
- 6 selectable Dim Modes (Standard, Stage, TV, Architectural, Theatre, & Stage 2)
- 4 selectable Dim Curves (Square, Linear, Inv. Squa & S.Curve)
- Refresh Rate: 900, 1000, 1100, 1200, 1300, 1400, 1500, 2500, 4000, 5000, 10k, 15k, 20k, 25KHz selectable

FEATURES:

- Primary / Secondary Mode
- Flicker Free operation (No flickering on camera)
- Produces powerful, smooth RGBAL color mixing with rich palettes of color
- Scissor yoke allows fixture to be mounted on truss or set on the ground
- Optional Barn Doors (BAR001) sold separately

ELECTRICAL:

- Auto sensing power supply: AC 100V/60Hz - 240V/50Hz
- Power Draw: 175W max
- Daisy chain up to 7 fixtures maximum

DIMENSIONS / WEIGHT:

- Dimensions (LxWxH) with Bracket: 13" x 10.3" x 7.5" / 330x261.9x190mm
- Dimensions (LxWxH) without Bracket: 8.6" x 7.5" x 7.5" / 218.5x190x190mm
- Weight: 9.45 lbs. / 4.30 kg.

ACCESSORIES:

- BAR001 - COB Cannon Wash Barn Doors

RATING / APPROVALS:

- cETLus

Specifications and manual are subject to improvement without prior written notice.

